

功能区域示意图

目 录

展商展位、海报张贴以及午餐报告区域平面示意图.....	01
展商A类展位平面示意图和实际现场图.....	02
展商B类展位平面示意图和实际现场图.....	03
展商C类展位平面示意图和实际现场图.....	04
午餐报告区域平面示意图和实际现场图.....	05
主会场以及workshop研讨会区域示意图和现场照片.....	06

展商展位、海报张贴以及午餐报告区域平面示意图

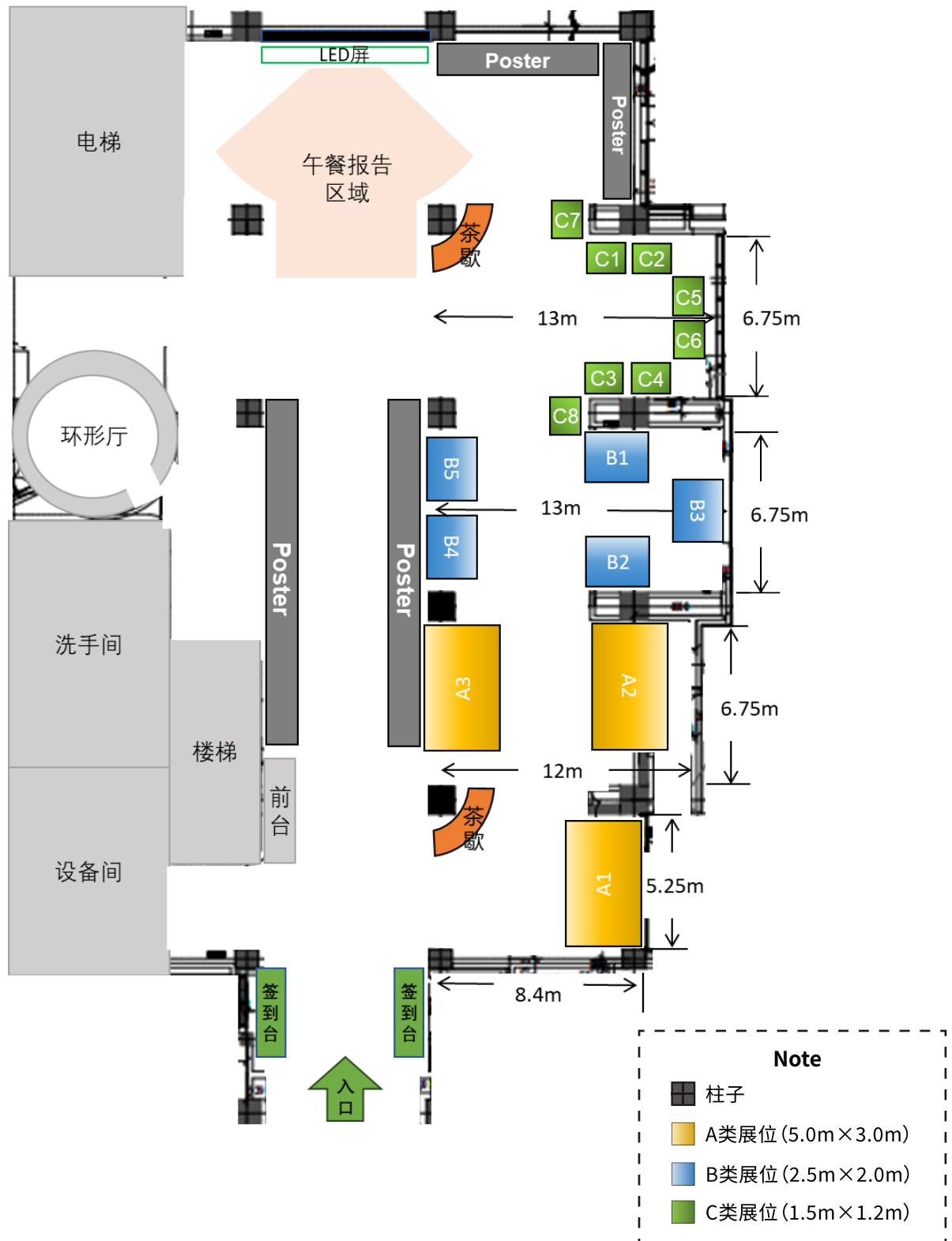

展商A类展位平面示意图和实际现场图

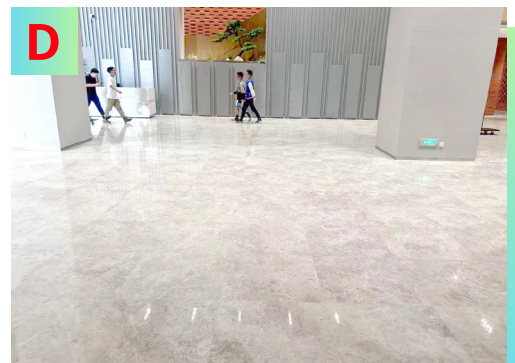
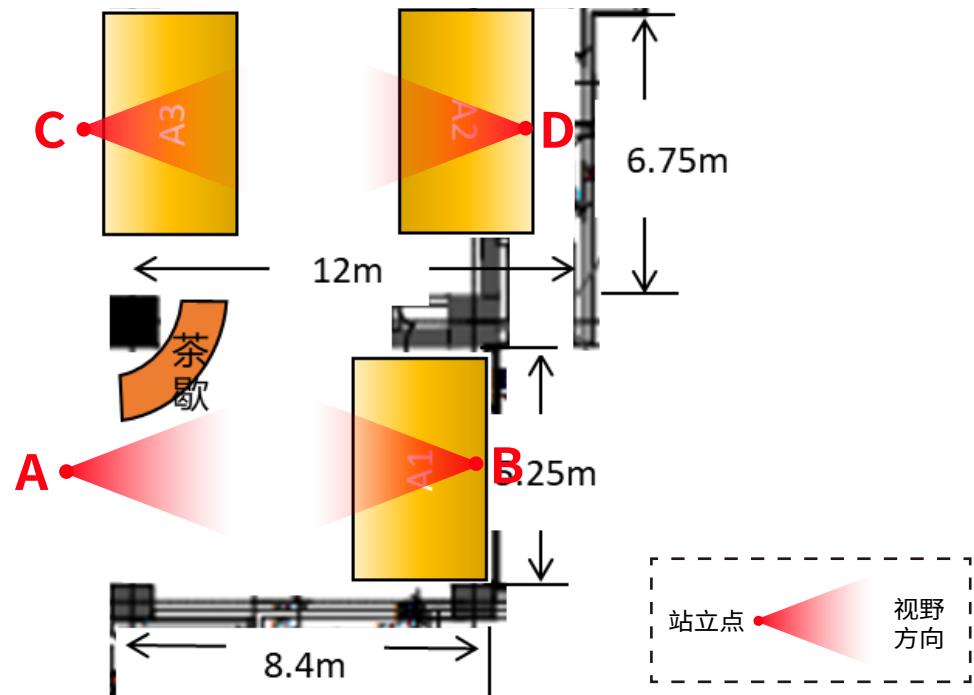

展商B类展位平面示意图和实际现场图

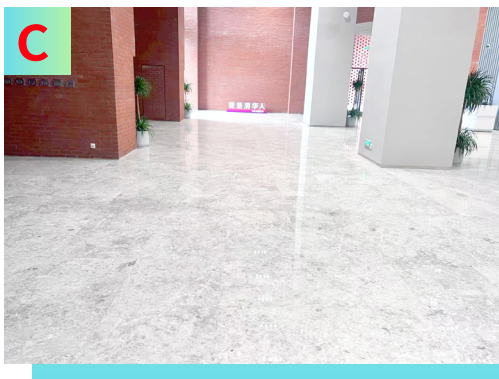
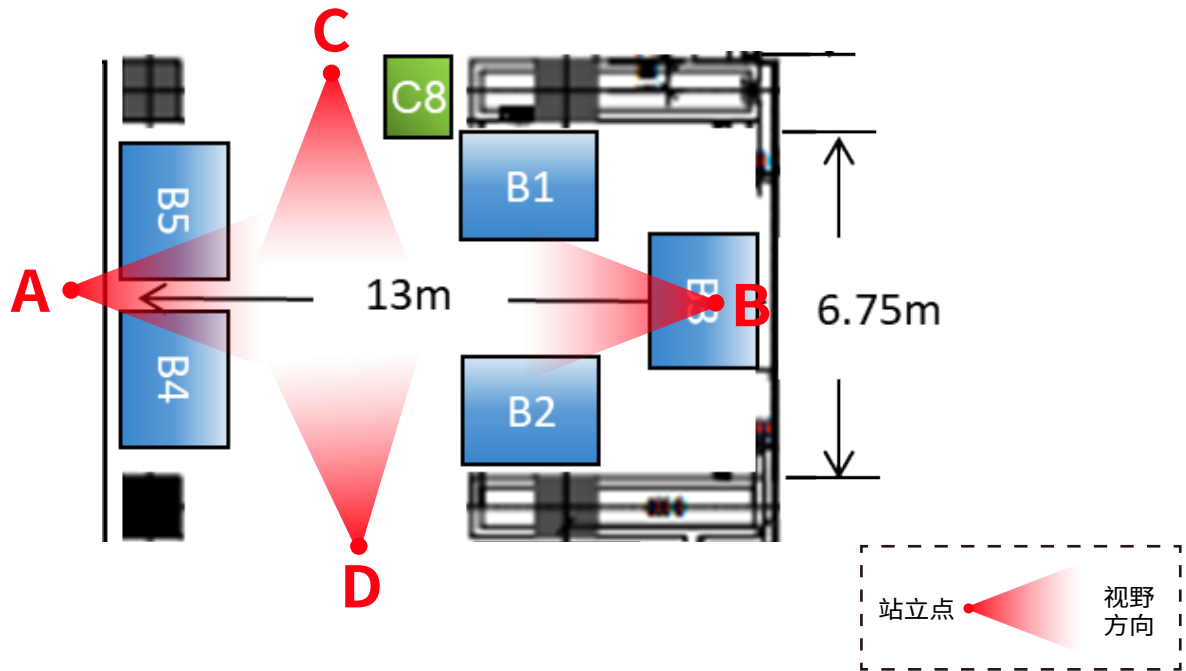

展商C类展位平面示意图和实际现场图

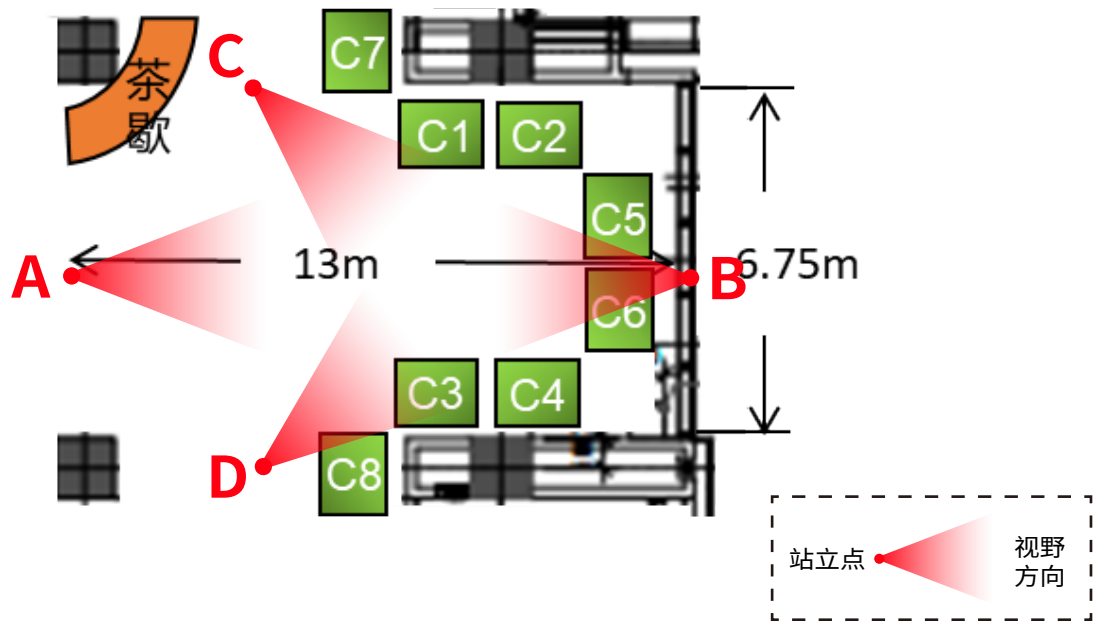

午餐报告区域平面示意图和实际现场图

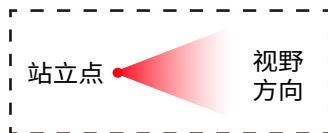
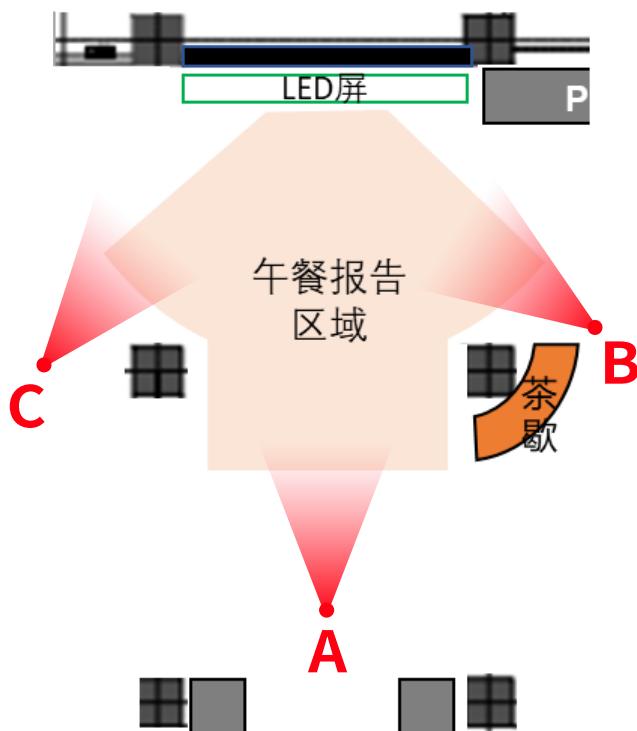

主会场以及workshop研讨会区域示意图和现场照片

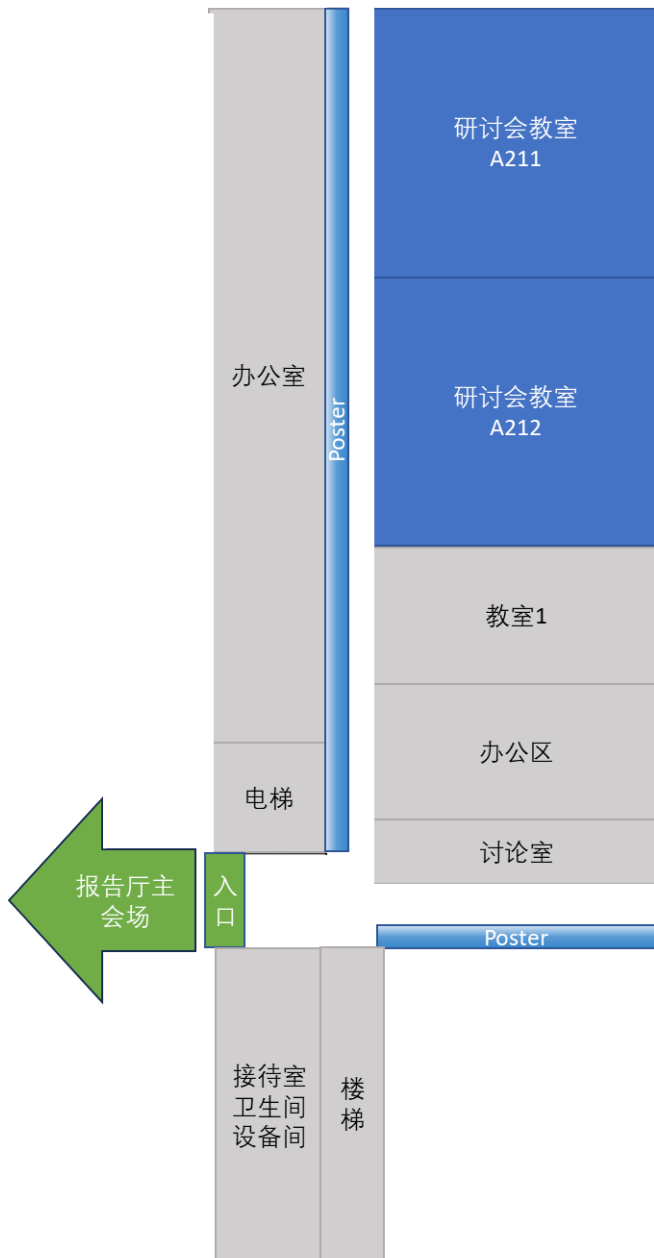

报告厅主会场观众席



报告厅主会场演讲席



研讨会教室A212

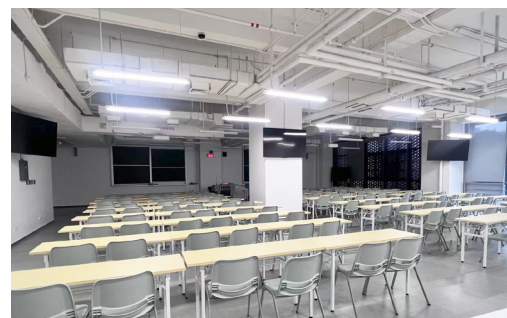

研讨会教室A211

Note
■ 报告厅主会场
■ 研讨会教室

*研讨会教室可用于Workshop